

Varenummer: 20115030SW20FHE
 Beskrivelse: E+G Rustfast lås GN 1150-FH-E
 Hygiejnisk design

Mål

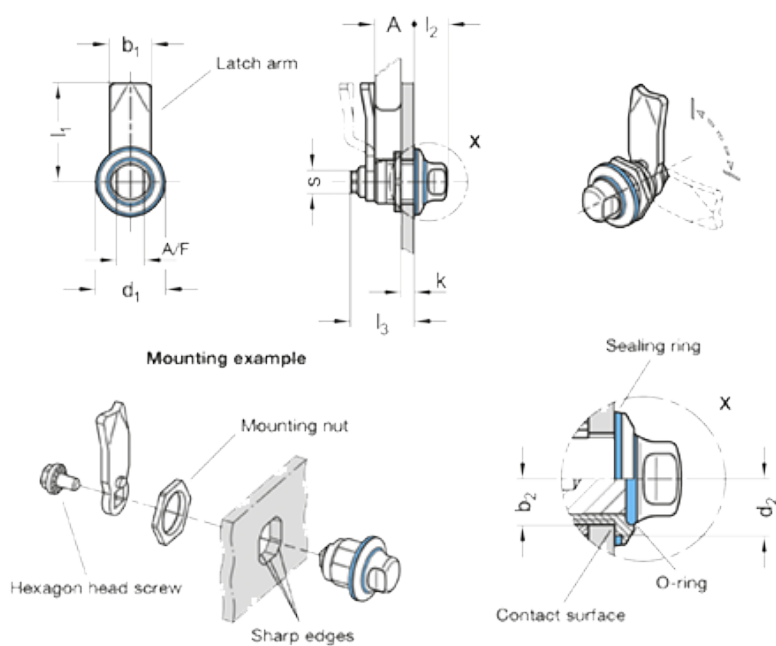

A/F = 13	l3 = 29
b1 = 19	kmin = 1.5
b2 = 10	la = 20
d1 = 30	s = 10
d2 = 13	
g = 125	
l1 = 45	
l2 = 15.3	